



# EDM35-2KF0A020A

EDS/EDM35

MOTOR FEEDBACK SYSTEMS ROTARY HIPERFACE DSL®

**SICK**  
Sensor Intelligence.

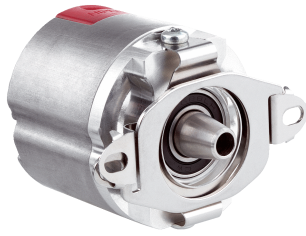

### Ordering information

Type	Part no.
EDM35-2KF0A020A	1090711

Other models and accessories → [www.sick.com/EDS\\_EDM35](http://www.sick.com/EDS_EDM35)

Illustration may differ



### Detailed technical data

#### Safety-related parameters

<b>Safety integrity level</b>	SIL2 (IEC 61508), SILCL3 (IEC 62061) <sup>1)</sup>
<b>Category</b>	3 (EN ISO 13849-1:2015)
<b>Systematic suitability</b>	SC 3 (IEC61508)
<b>Test rate</b>	24 h
<b>Maximum demand rate</b>	216 µs
<b>Performance level</b>	PL d (EN ISO 13849-1:2015)
<b>Basis for safety function</b>	Safe singleturn absolute position
<b>Safety-related resolution</b>	13 bits
<b>PFH<sub>D</sub>: Probability of dangerous failure per hour</b>	31.0 x 10 <sup>-9</sup> <sup>2)</sup>
<b>T<sub>M</sub> (mission time)</b>	20 years
<b>Safety-related accuracy</b>	0.045° <sup>3)</sup>

<sup>1)</sup> For more detailed information on the exact configuration of your machine/unit, please consult your relevant SICK branch office.

<sup>2)</sup> At 60 °C ambient temperature.

<sup>3)</sup> The safety-related accuracy indicates the maximum position error limit with which safety functions can be supported.

#### Performance

<b>Resolution per revolution</b>	20 bit
<b>Number of the absolute ascertainable revolutions</b>	4,096
<b>Signal noise (σ)</b>	± 3 " <sup>1)</sup>
<b>System accuracy</b>	± 50 " <sup>2)</sup>
<b>Speed when switching on/resetting the motor feedback system</b>	≤ 6,000 min <sup>-1</sup>
<b>Available memory area</b>	8,192 Byte

<sup>1)</sup> Repeatability standard deviation in accordance with DIN 1319-1:1995.

<sup>2)</sup> In accordance with DIN ISO 1319-1, position of the upper and lower error limit depends on the installation situation, specified value refers to a symmetrical position, i.e. deviation in upper and lower direction is the same.

## Interfaces

<b>Code sequence</b>	Increasing, when turning the shaft For clockwise rotation, looking in direction "A" (see dimensional drawing)
<b>Communication interface</b>	HIPERFACE DSL®
<b>Initialization time</b>	≤ 500 ms <sup>1)</sup>
<b>Measurement external temperature resistance</b>	32-bit value, without prefix (1 Ω) 0 ... 209.600 Ω <sup>2)</sup>

<sup>1)</sup> From reaching a permitted operating voltage.

<sup>2)</sup> Without sensor tolerance; at -40 °C ... +160 °C: NTC +2K; PTC+3K (KTY84-130/PT1000). For additional conversion function of PT1000 to KTY84/130, see technical description.

## Electrical data

<b>Connection type</b>	Male connector, 4-pin
<b>Supply voltage</b>	7 V ... 12 V
<b>Warm-up time voltage ramp</b>	Max. 180 ms <sup>1)</sup>
<b>Power consumption</b>	≤ 150 mA <sup>2)</sup>

<sup>1)</sup> Duration of voltage ramp between 0 and 7.0 V.

<sup>2)</sup> Current rating applies when using interface circuit suggestions as shown in HIPERFACE DSL® manual (8017595).

## Mechanical data

<b>Shaft version</b>	Tapered shaft
<b>Dimensions</b>	See dimensional drawing
<b>Weight</b>	≤ 100 g
<b>Moment of inertia of the rotor</b>	5 gcm <sup>2</sup>
<b>Operating speed</b>	≤ 9,000 min <sup>-1</sup>
<b>Angular acceleration</b>	≤ 250,000 rad/s <sup>2</sup>
<b>Start up torque</b>	≤ 0.6 Ncm, +20 °C
<b>Permissible movement of the drive element, static</b>	± 1 mm axial <sup>1)</sup>
<b>Permissible movement of the drive element, dynamic</b>	± 0.025 mm radial <sup>2)</sup>
<b>Life of ball bearings</b>	50,000 h at 6,000 min <sup>-1</sup> (at a flange temperature of 70 °C)

<sup>1)</sup> Temperature expansion, mechanical attachment.

<sup>2)</sup> For SIL2 version.

## Ambient data

<b>Operating temperature range</b>	-40 °C ... +115 °C <sup>1)</sup>
<b>Storage temperature range</b>	-40 °C ... +125 °C, without package
<b>Relative humidity/condensation</b>	90 %, Condensation not permitted
<b>Resistance to shocks</b>	100 g, 6 ms (according to EN 60068-2-27)
<b>Frequency range of resistance to vibrations</b>	50 g, 10 Hz ... 2,000 Hz (according to EN 60068-2-6)
<b>EMC</b>	According to EN 61000-6-2: 2016, EN 61000-6-4: 2006, IEC 6100-6-7: 2014 <sup>2)</sup>
<b>Enclosure rating</b>	IP40, When cover is closed and mating connector is attached (acc. to EN 60529-1)

<sup>1)</sup> Given typical thermal connection between motor flange and encoder stator coupling. The max. internal sensor temperature may not exceed 125 °C.

<sup>2)</sup> According to the listed standards, EMC is guaranteed if the motor feedback system with mating connector inserted is connected to the central grounding point of the motor controller via a cable shield. If other shielding concepts are used, users must perform their own tests. Class A device.

### Classifications

<b>ECl@ss 5.0</b>	27270590
<b>ECl@ss 5.1.4</b>	27270590
<b>ECl@ss 6.0</b>	27270590
<b>ECl@ss 6.2</b>	27270590
<b>ECl@ss 7.0</b>	27270590
<b>ECl@ss 8.0</b>	27270590
<b>ECl@ss 8.1</b>	27270590
<b>ECl@ss 9.0</b>	27270590
<b>ECl@ss 10.0</b>	27273805
<b>ECl@ss 11.0</b>	27273901
<b>ETIM 5.0</b>	EC001486
<b>ETIM 6.0</b>	EC001486
<b>ETIM 7.0</b>	EC001486
<b>UNSPSC 16.0901</b>	41112113

### Dimensional drawing (Dimensions in mm (inch))

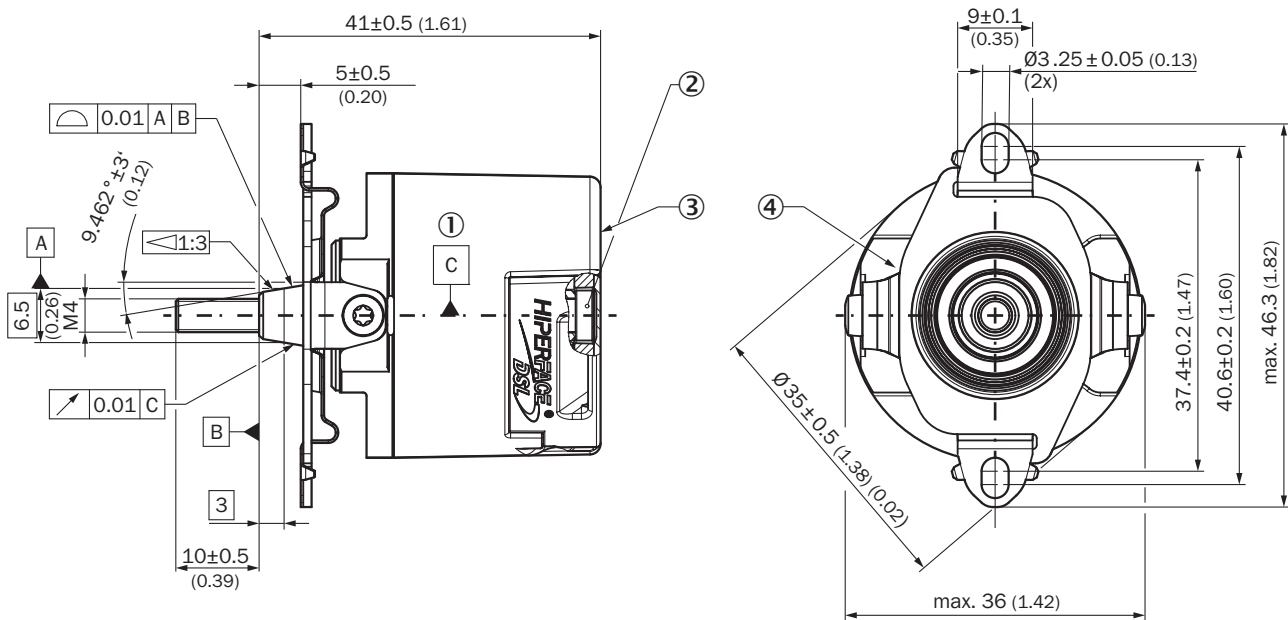

- ① Bearing of the encoder shaft
- ② Torx 15 cylinder screw
- ③ Measuring point for vibrations
- ④ Measuring point for operating temperature





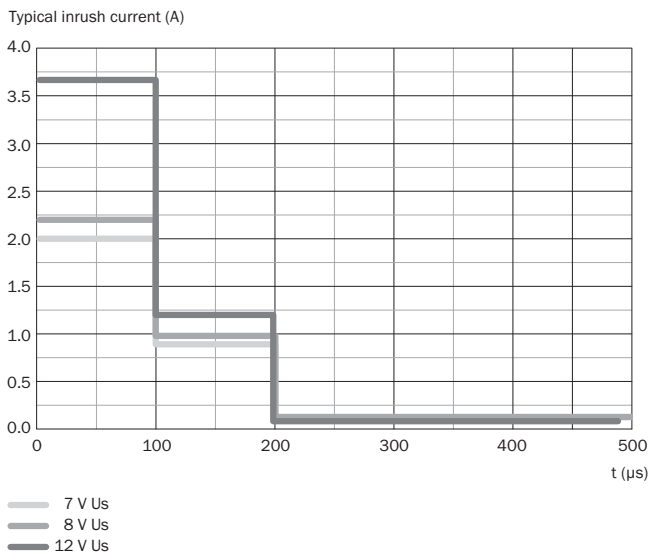

### Diagrams



### Recommended accessories

Other models and accessories → [www.sick.com/EDS\\_EDM35](http://www.sick.com/EDS_EDM35)

	Brief description	Type	Part no.
<b>Nuts and screws</b>			
	500 pieces, Screws with Precote 85-8 coating; M4*48 (4093779)	BEF-MK-S09	2103244
	100 pieces, Screws with Precote 85-8 coating; M4*48 (4093779)	BEF-MK-S10	2103272
	10 pieces, Screws with Precote 85-8 coating; M4*48 (4093779)	BEF-MK-S11	2103274
<b>Plug connectors and cables</b>			
	Head A: female connector, stranded wire, 4-pin, straight Head B: Flying leads Cable: HIPERFACE DSL®, unshielded, 0.2 m	DOL-0B02-GOM2XC2	2079920
	Head A: female connector, stranded wire, 4-pin, straight Head B: Flying leads Cable: HIPERFACE DSL®, twisted, shielded, 0.36 m	DOL-0B02-GOM3AC2	2108944
<b>Programming and configuration tools</b>			
	SVip® LAN programming tool for all motor feedback systems	PGT-11-S LAN	1057324
	SVip® WLAN programming tool for all motor feedback systems	PGT-11-S WLAN	1067474

## SICK AT A GLANCE

SICK is one of the leading manufacturers of intelligent sensors and sensor solutions for industrial applications. A unique range of products and services creates the perfect basis for controlling processes securely and efficiently, protecting individuals from accidents and preventing damage to the environment.

We have extensive experience in a wide range of industries and understand their processes and requirements. With intelligent sensors, we can deliver exactly what our customers need. In application centers in Europe, Asia and North America, system solutions are tested and optimized in accordance with customer specifications. All this makes us a reliable supplier and development partner.

Comprehensive services complete our offering: SICK LifeTime Services provide support throughout the machine life cycle and ensure safety and productivity.

For us, that is “Sensor Intelligence.”

## WORLDWIDE PRESENCE:

Contacts and other locations –[www.sick.com](http://www.sick.com)